

SAP5000D

Differential Probe

User Manual

EN01A



CONTENTS

1	Introduction	2
2	Safety Instructions	3
2.1	Symbols	3
2.2	Operating Environment.....	3
2.3	Calibration.....	4
2.4	Cleaning.....	4
2.5	Abnormalities	4
3	First Steps	5
3.1	Delivery Checklist	5
3.2	Functional Check	5
3.3	Quality Assurance.....	6
3.4	Maintenance Agreement	6
4	Probe Technical Specifications	7
4.1	Model and Specifications	7
4.2	Accessories	11
4.3	Probe Dimensions	12
5	Probe Operation.....	13
5.1	Connecting the Probe to an Oscilloscope.....	13
5.2	Connecting the Probe to the Test Circuit.....	13
5.3	Probe Head Selection.....	14
5.3.1	DSI-50 Differential Input Soldering Type.....	14
5.4	Soldering-Type Probe Head Usage	15
5.4.1	Soldering Method for Lead Resistance or Silver Wire on the Probe Tip	15
5.4.2	Probe Head Stabilization.....	18
5.4.3	Connecting SAP5000D Probe and Circuit Board with DSI-50 Head.....	18
5.4.4	Removing the DSI-50 Head from the Circuit Board.....	21

1 Introduction

This user manual contains important safety information related to the SAP5000D Differential Active Probe, as well as a basic tutorial on the probe's operational use.

2 Safety Instructions

This section contains essential information and warnings that must be adhered to while operating the probe under the respective safety conditions. In addition to the safety precautions outlined in this section, you must also follow recognized safety procedures.

1. Connect the probe to the oscilloscope before probing the signal.
2. Intended for indoor use only.
3. Keep the product's surface clean and dry.
4. Do not operate in damp environments.
5. Do not operate in potentially explosive atmospheres.
6. Maintenance procedures should only be performed by qualified technicians.
7. Ensure proper connection of signal wires, keeping the signal ground at the same potential as the ground voltage. Do not connect the ground wire to high voltage sources. During testing, avoid touching exposed contacts and components.
8. If you suspect a product malfunction, refrain from further operation. In the event of suspected damage to the product, seek examination by qualified service personnel.

2.1 Symbols

The following symbol may appear on the product's exterior or within this manual, signifying a need for special attention to safety.

	<p>This symbol is used in areas that require caution. Refer to accompanying information or documents to prevent personal injury or damage to the equipment.</p>
---	---

2.2 Operating Environment

This product is intended for indoor operation only. Before using this product, please ensure that the operating environment remains within the following parameter ranges.

Temperature: 5°C to 40°C.

Humidity: Maximum relative humidity of 80% at 30°C, linearly decreasing to 50% at 40°C.

Altitude: Up to 10,000 feet (3,048 meters).

Note: Consider direct sunlight, electric heaters, and other heat sources when evaluating temperature.



Warning: Do not operate this product in explosive, dusty, or humid atmospheres.



Caution: Do not exceed the specified maximum input voltage. For details, please refer to the technical data.

2.3 Calibration

The recommended calibration interval is one year and should be performed by personnel with the appropriate qualifications.

2.4 Cleaning

Only use a soft, damp cloth to clean the probe's surface. Do not use chemicals or corrosive substances. Under no circumstances should moisture be allowed to infiltrate the probe. To avoid damaging the probe, disconnect it from the oscilloscope before cleaning.



The probe case is not sealed and should never be immersed in any fluid.

2.5 Abnormalities

Use this probe only for the purpose specified by the manufacturer.

The probe may be damaged if it exhibits visible damage or experiences significant transport pressure.

Bending the probe cable may affect the high-frequency performance of the probe.

If you suspect probe damage, disconnect it from the oscilloscope immediately.

To use the probe correctly, carefully read all instructions and labels.



Warning: Using the probe in a manner not specified by the manufacturer may damage the probe. This probe and related accessories should not be directly connected to the human body or used for patient monitoring.

3 First Steps

3.1 Delivery Checklist

First, check that all items listed on the packing list have been delivered. If you note any omissions or damage, please contact your nearest SIGLENT customer service center or distributor as soon as possible. If you fail to contact us immediately in case of omission or damage, we will not be responsible for replacement.



3.2 Functional Check

To perform a function check, you will need an oscilloscope with SAPBus interface support. Follow these steps to check the probe's function:

1. Power on the oscilloscope and allow it to warm up for 20 minutes.
2. Connect the active probe to Channel 1 of the oscilloscope.
3. Open the parameter panel for Channel 1 and inspect the probe information, including the probe model, serial number, bandwidth, impedance, capacitance, and attenuation ratio.
4. Set the vertical scale for Channel 1 to 1V/div.
5. Set the offset voltage for Channel 1 to 0V.
6. Measure the average voltage for Channel 1. The reading should be within $\pm (1.5\% * \text{full-scale reading} + 10\text{mV})$. If the reading is outside this range, the check does not pass.
7. Change the vertical scale for Channel 1 to 500mV/div, 200mV/div, 100mV/div, 50mV/div, 20mV/div, and 10mV/div, respectively. Repeat step 6 for each scale to check the average voltage readings at each scale level.

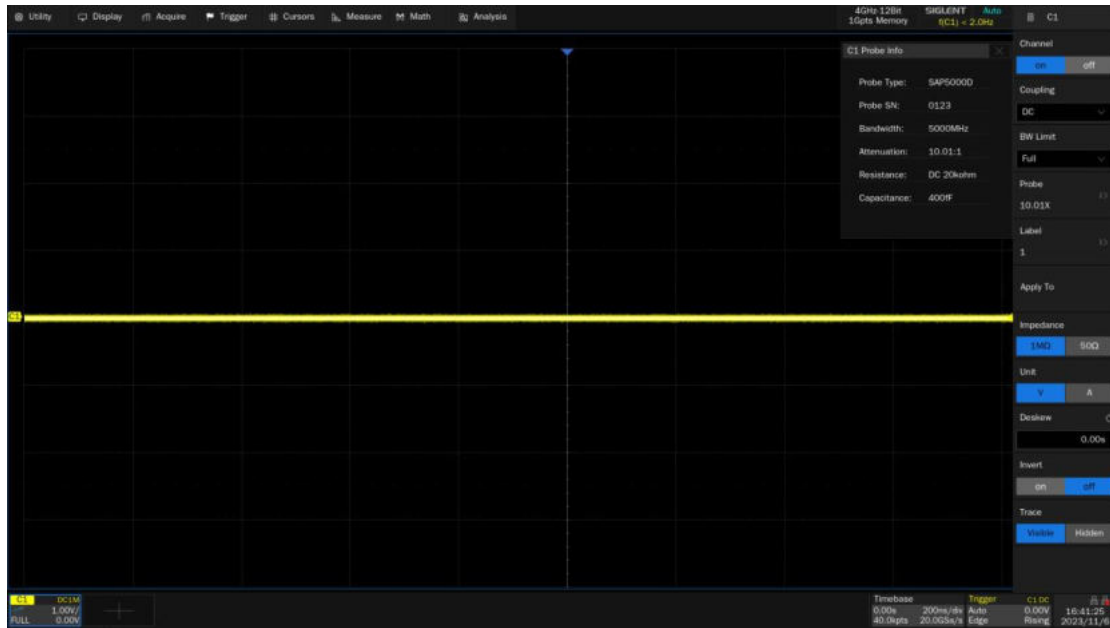

3.3 Quality Assurance

The probe is covered by a 1-year warranty from the date of shipment, provided it is used and operated under normal conditions. SIGLENT can repair or choose to replace any product returned to an authorized service center during the warranty period. We must first examine the product to make sure that the defect is caused by the process or material, not by abuse, negligence, accident, abnormal conditions, or operation.

SIGLENT shall not be responsible for any defect, damage, or failure caused by any of the following:

1. Repairs or installation conducted by individuals not authorized by SIGLENT.
2. Connection of incompatible devices and improper connections.
3. Any damage or failure resulting from the use of products provided by non-SIGLENT suppliers.

3.4 Maintenance Agreement

We offer various services through maintenance agreements. We offer extended warranties, and you can create a maintenance cost budget after the one-year warranty period. We offer installation, training, enhancements, on-site repairs, and other services through dedicated supplementary support agreements. For more information, please contact the SIGLENT customer service center or your national distributor.

4 Probe Technical Specifications

SAP5000D is a high-bandwidth differential active probe known for its features such as high bandwidth, low noise, and high input impedance, making it suitable for measuring high-speed signals. Its high input resistance and low input capacitance characteristics ensure minimal load introduced to the measurement system.

The SAP5000D active probe utilizes the SAPBus interface and is compatible with oscilloscopes that support the SAPBus interface, such as the SDS5000X, SDS6000 Pro, and SDS7000A series oscilloscopes. The SAP series active probes do not require external power sources as the oscilloscope provides power and communication interface to the active probe through the SAPBus. When connected to the oscilloscope, the SAP series active probes allow you to read probe information from the oscilloscope's interface.

Here are the performance characteristics:

- Probe Bandwidth: DC to >5GHz
- Single-ended input resistance: 10k Ω
- Differential input resistance: 20k Ω
- Probe gain: $\times 10$
- Differential input capacitance: 400 fF
- $\pm 2.5V$ input dynamic range
- $\pm 12V$ offset voltage setting range
- SAPBus interface

4.1 Model and Specifications

The specifications of the probe need to meet the following conditions:

1. The probe is within its valid calibration period.
2. The environmental temperature is within $25^{\circ}C \pm 5^{\circ}C$.
3. The probe is correctly connected to the oscilloscope.
4. The probe and oscilloscope are in a thermally stable environment, and both the probe and oscilloscope have been preheated for at least 20 minutes.

Probe Model and Specification Parameters:

Parameters	SAP5000D
Bandwidth (Probe only)	>5 GHz
Bandwidth (with Oscilloscope)	4GHz (SDS7404A)
Differential input capacitance	400fF
Differential input resistance	20 K Ω
Single-ended input resistance	10 K Ω
Offset range	± 12 V
Attenuation ratio (DC)	$\div 10$
Offset accuracy	< 3%
DC gain accuracy	< 3%
Input dynamic range	± 2.5 V
Damage voltage	20 V
Cable length	130 cm

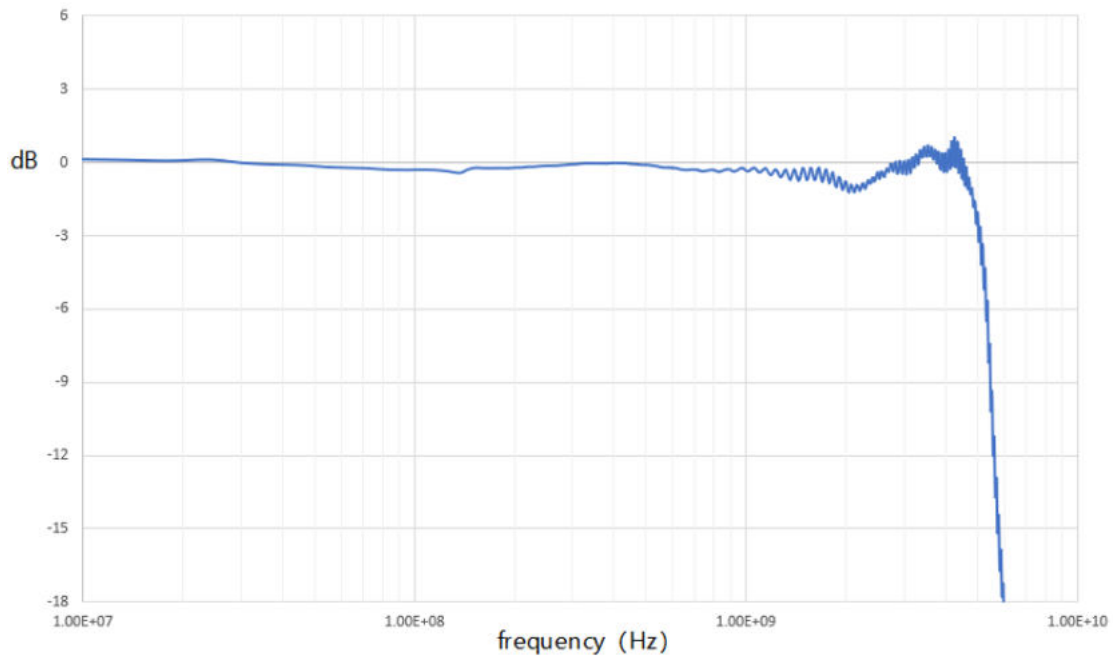

SAP5000D Frequency Response (Soldered 24.9 Ω Lead Resistance)

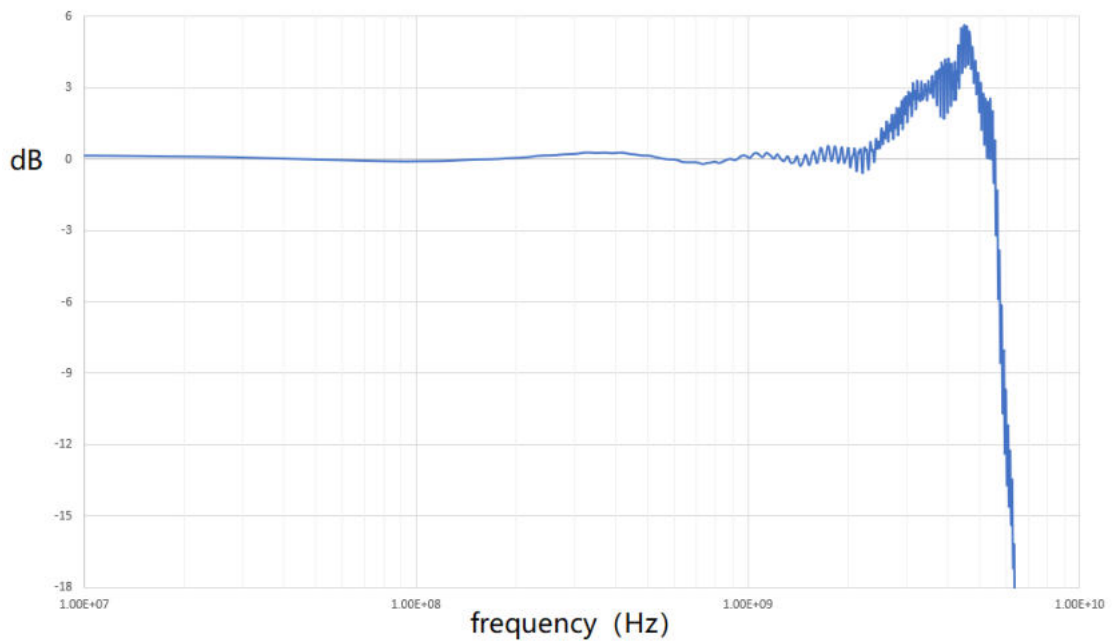

SAP5000D Frequency Response (Soldered 3mm Silver Wire)

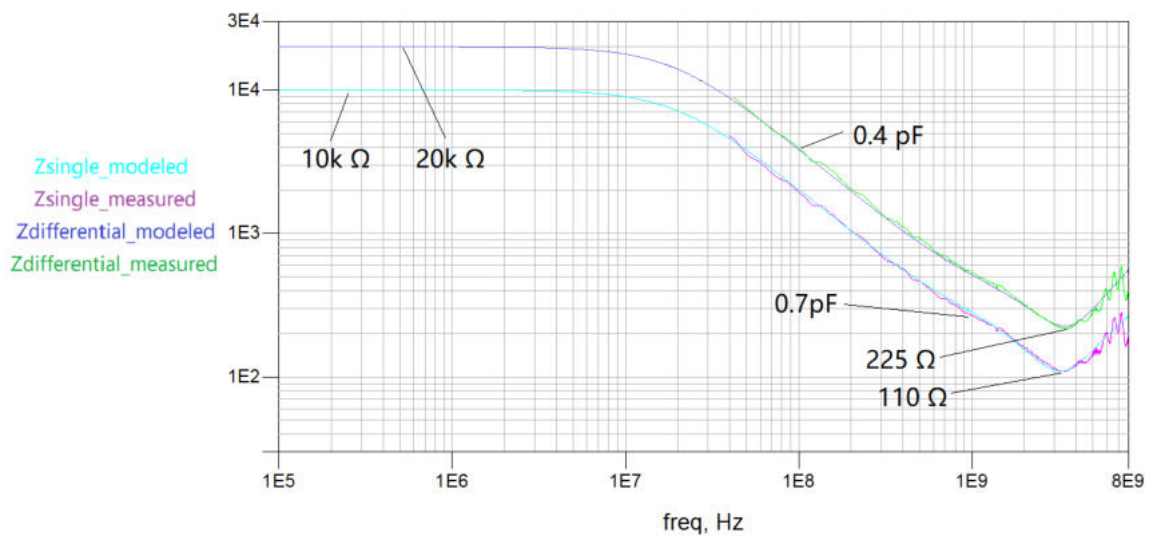

SAP5000D Input Impedance (Soldered 24.9Ω Lead Resistance)

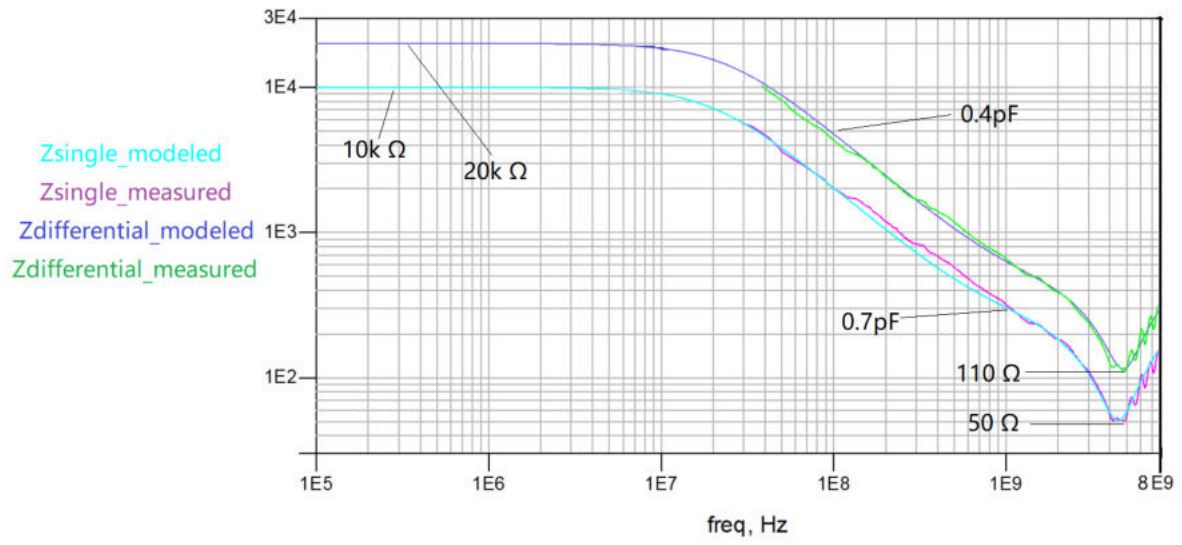

SAP5000D Input Impedance (Soldered 3mm Silver Wire)

4.2 Accessories

The standard accessories included with the active probe SAP5000D are as follows:

Standard Accessories	Part Number	Quantity	Unit
Head DSI-50	1.99.20.00.023R	1	pcs
10cm Ground Wire	2.52.42.11.018	2	pcs
24.9Ω Lead Resistance	2.45.01.01.305	20	pcs
Silver Wire	2.52.42.11.037	1	Meter
Colored Rings (4 colors)	2.75.23.10.005	2	Set

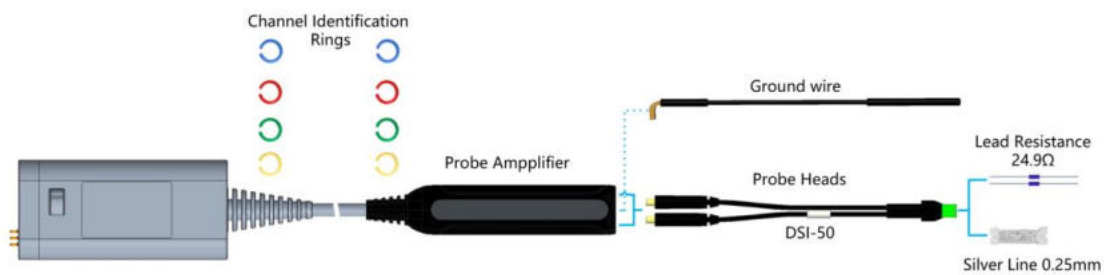

Probe Accessories Illustration



Silver Wire: Diameter 0.25mm, used to connect the DUT and the probe tip.



Lead Resistance: 24.9Ω, wire diameter 0.4mm, used to connect the DUT and the probe tip.



Probe Head: SMP interface, connects to the probe, and the tip can be soldered to the lead resistance or silver wire.



10cm Ground Wire: One end has a plug, and the other end has a socket, used for grounding.



Color Identification Card: Used when multiple probes are connected to differentiate the oscilloscope channels to which the probes are connected.

4.3 Probe Dimensions

Unit: mm

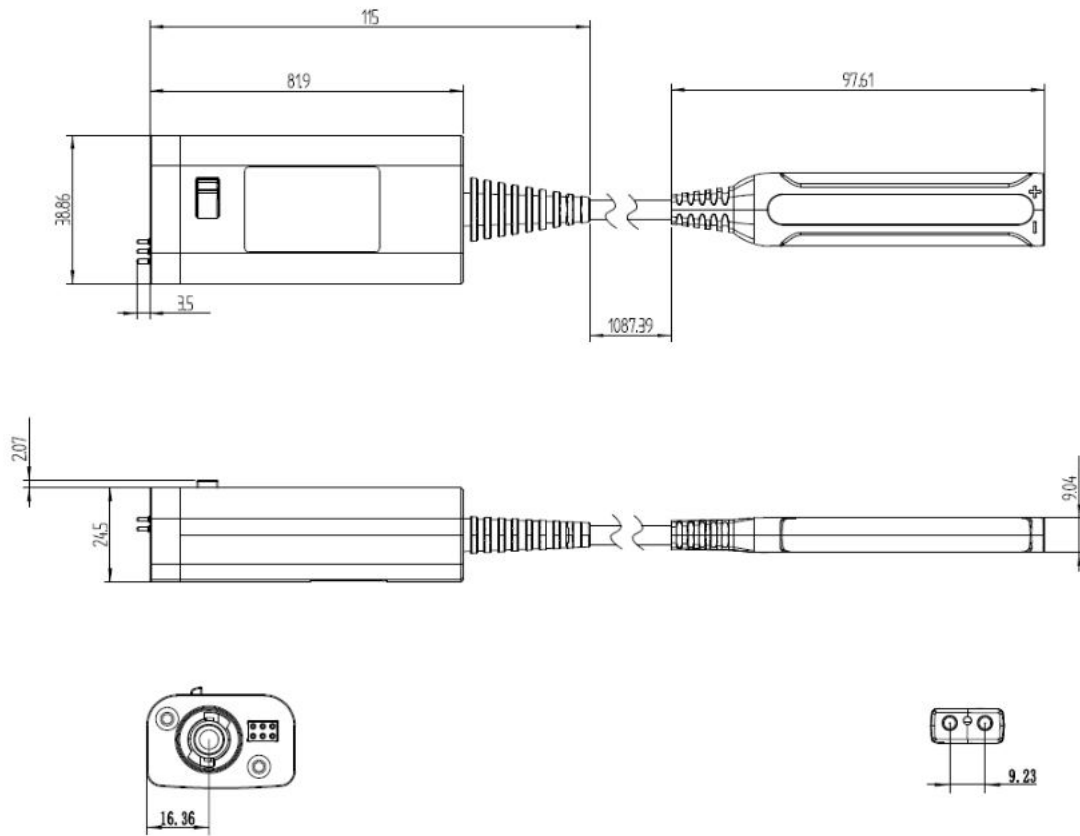

5 Probe Operation

The SAP5000D active probe is a precision test and measurement instrument. Avoid excessive pulling on the cable during use, and when not in use, store the probe in the provided probe pack.



Electrostatic Sensitive: The probe is sensitive to ESD. When using the probe, adhere to ESD protection procedures.

5.1 Connecting the Probe to an Oscilloscope

The SAP5000D is compatible with oscilloscopes that support the SAPBus interface, such as the SDS5000X, SDS6000 Pro, and SDS7000A series oscilloscopes.

When the probe is connected to the oscilloscope, the oscilloscope can automatically identify the probe model and adjust display scales and measurements accordingly. Basic information about the probe, such as the model and serial number, can be viewed on the oscilloscope's user interface. After connecting the probe, the maximum vertical scale on the oscilloscope is 1V/div, and the DC offset can be set in the range of $\pm 12V$.

5.2 Connecting the Probe to the Test Circuit

The internal amplifier of the probe has a limited linear operating range. To ensure that the input linearity error is less than 1%, the amplitude of the input signal needs to be limited to $\pm 2.5V$. The probe features a DC offset adjustment function, which allows you to offset the DC component in the test signal for optimal probe performance. The DC offset adjustment range is $\pm 12V$.

To maintain the high-frequency performance of the probe and minimize parasitic effects introduced during measurements, the probe tip and the circuit under test are connected by soldering. Depending on the size of the point under test, you can choose to solder lead resistance or silver wire. To solder effectively, select appropriate soldering tools and materials to prevent damage to the probe and DUT (Device Under Test). Both the probe and the DUT must be securely fixed after soldering to prevent damage to the tested circuit.

When using the probe to test signals, it's essential to minimize parasitic capacitance or inductance introduced in the test setup to ensure probe performance. Parasitic inductance or capacitance can lead to ringing during fast edge testing or slow down the rise time of fast edges.

To reduce the test loop, keep the soldered leads as short as possible and minimize the ground path's length. Otherwise, the test loop may couple with electromagnetic fields in the environment, resulting in increased noise picked up by the probe.

Probes are sensitive to ESD. Follow ESD protection procedures when using the probe to prevent damaging the probe.

5.3 Probe Head Selection

Different probe heads are suitable for different usage scenarios, and users can choose as needed. Siglent will continue to introduce various types of probe heads.

5.3.1 DSI-50 Differential Input Soldering Type

This probe head can measure both differential and single-ended signals, with characteristics of high bandwidth and low input capacitance. The tip of this head can be soldered to the DUT, freeing up hands and providing a reliable connection. We provide leads with a minimum diameter of 0.25mm, allowing signal acquisition at very small and narrow measurement points.



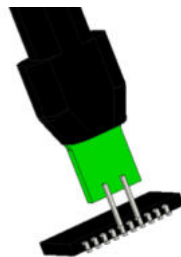

Head Models	Bandwidth (GHz)	Input Capacitance (fF)	Purpose
DSI-50	5	400	Measure Differential or Single-Ended Signals



	If you need to replace the lead resistance or silver wire on the probe tip, please refer to "Section 5.4.1 Soldering Method for Lead Resistance or Silver Wire on the Probe Tip."
---	---

	Avoid applying too much solder to the lead resistance body, as it may cause damage to the resistance.
---	---

	When soldering leads onto the DUT, use a sufficient amount of flux. Reliable soldering can be achieved with a moderate amount of solder after using flux.
---	---

	Use a fixed stand or tape to secure the probe and DUT, reducing the stress on the soldering points.
---	---

5.4 Soldering-Type Probe Head Usage

Before using a soldering-type probe head, please carefully read the following usage instructions to avoid damaging the probe and the circuit board under test.

5.4.1 Soldering Method for Lead Resistance or Silver Wire on the Probe Tip

If you need to replace the lead resistance or silver wire due to damage, follow these steps for replacement.

Soldering Preparation

Materials or Tools:
Vise or equivalent fixture for securing the tip.
Adjustable-temperature fine-tip soldering iron.
Solder wire.
Fine stainless steel tweezers.
Flux.
Caliper.
Wire cutters.

Soldering Steps

1. Use a vise or fixture to secure the tip for soldering. If the fixture has sharp edges, wrap it with tape to protect the head.

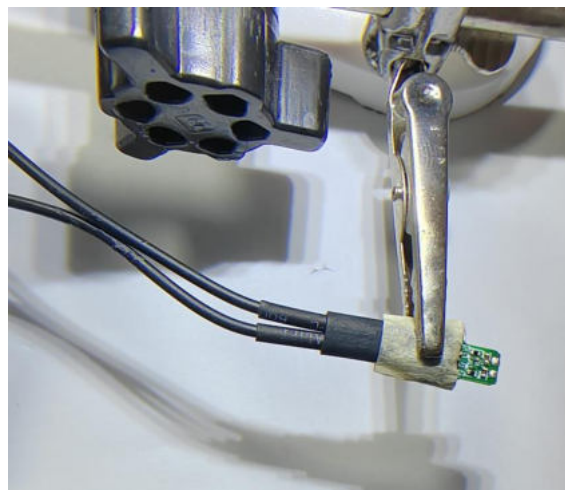

- If you need to remove the existing or damaged leads, grip the leads with tweezers and gently pull them upward. Ensure the soldering iron contacts the solder point for a sufficient amount of time to detach the leads from the tip.

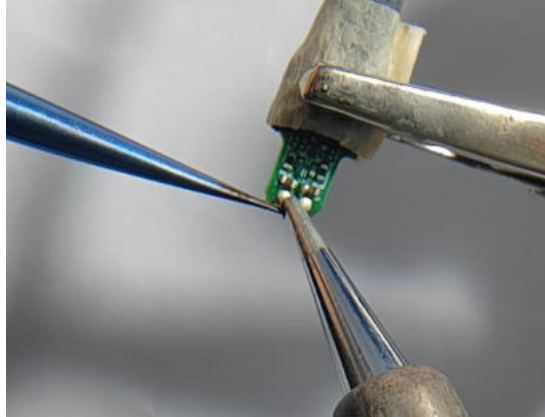

	<p>To avoid overheating and damaging the circuit board, do not allow the soldering iron to contact the solder point for longer than necessary. The solder joints are very small and have low thermal mass, so they will melt quickly.</p>
---	---

- Fill the mounting hole with solder, preparing it for the new leads.
- To reduce the soldering temperature, it is recommended to apply flux to the soldering area.
- Prepare the lead resistance for connection to the head's PCB. Trim the lead resistance leads as shown in the diagram. The wires soldered to the head's PCB should have a 90° bend, with a bend length of about 1mm, to enter the through-hole in the probe tip's PCB. The processed lead resistance should look as shown in the diagram.
- Alternatively, prepare the silver wire and trim it to the state shown in the diagram.

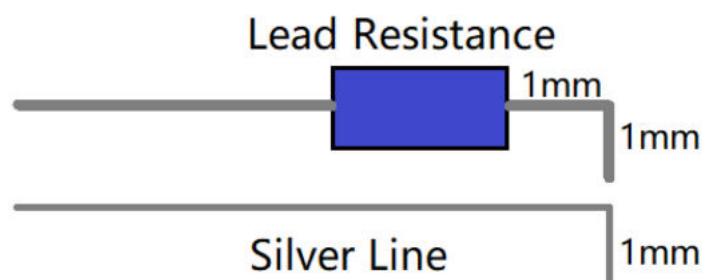

7. Hold the lead of the lead resistance or silver wire with tweezers in one hand, and in the other hand, hold the soldering iron to place the end of the lead resistance or silver wire (the 90° bend) over the filled solder hole. Touch the soldering iron to the side of the hole. As the solder in the hole melts, the lead of the lead resistance or silver wire will drop into the hole. Once the lead drops into the hole, immediately remove the soldering iron.

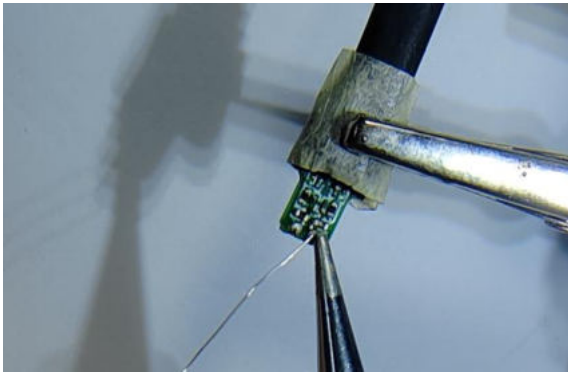

Silver Wire Soldering

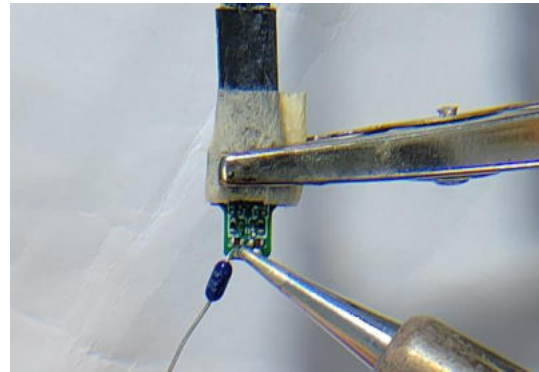

Lead Resistance Soldering

8. After soldering, use wire cutters to trim the lead to a length that is just right to solder to the test point on the circuit board under test. The shorter the lead, the better. For silver wire, a length shorter than 3mm is recommended, and for lead resistance leads, a length shorter than 2mm is suggested.

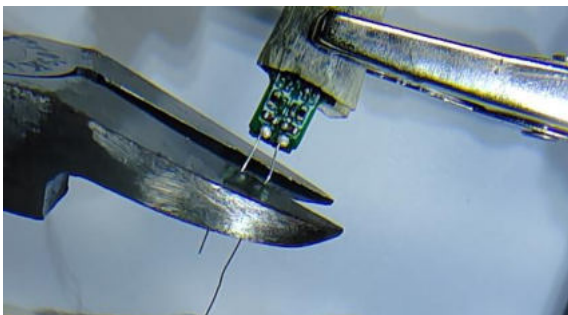

Silver Wire Cutting

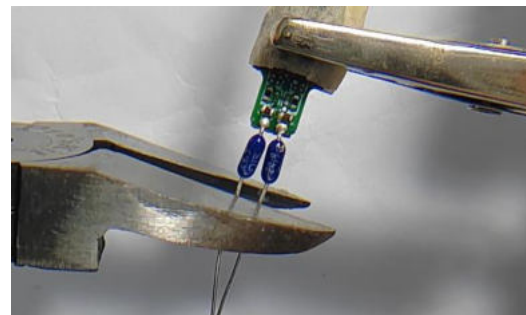

Lead Resistance Cutting

5.4.2 Probe Head Stabilization

During the use of the probe, securely fixing the probe head will extend its lifespan and prevent damage to the test points due to stress. You can use 3M double-sided tape or adhesive tape to secure the probe head.

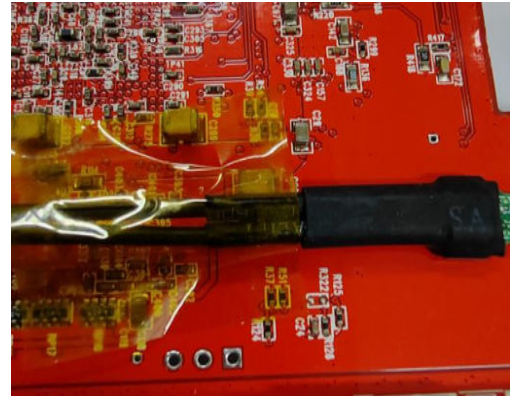
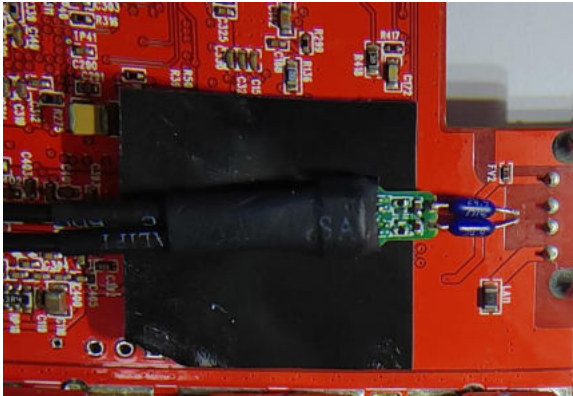

	<p>When using double-sided tape or adhesive tape to fix the probe head, it may inevitably leave marks on the circuit board.</p>
--	---

5.4.3 Connecting SAP5000D Probe and Circuit Board with DSI-50 Head

1. Solder the lead resistance or silver wire onto the DSI-50 head as per the soldering method in Section 5.4.1. Apply solder at the location marked in red.

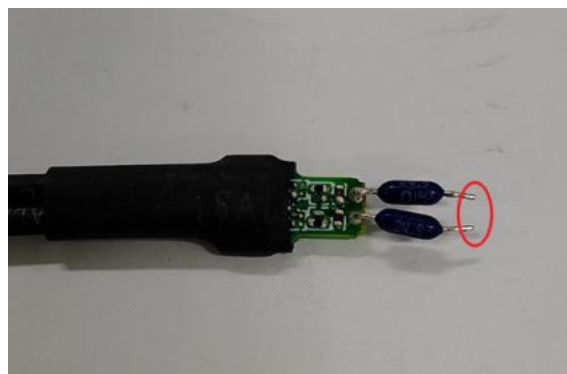

2. Apply flux to the test points on the circuit board, then add solder. If the test points are through-holes, it is recommended to use low-temperature solder.

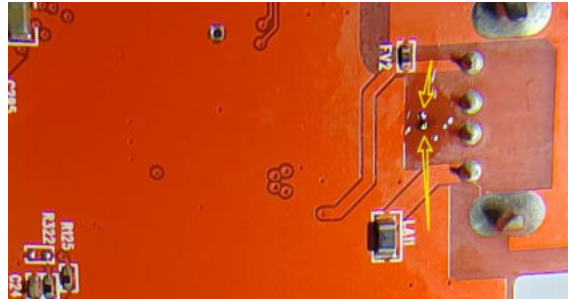

3. Choose the method to secure the probe head.

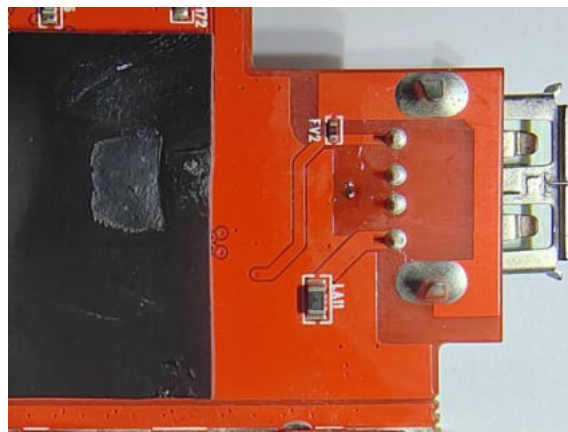

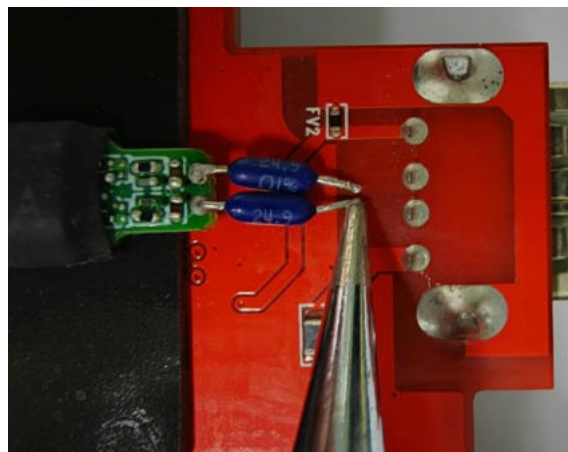

4. Solder the tip of the head to the test points on the circuit board.

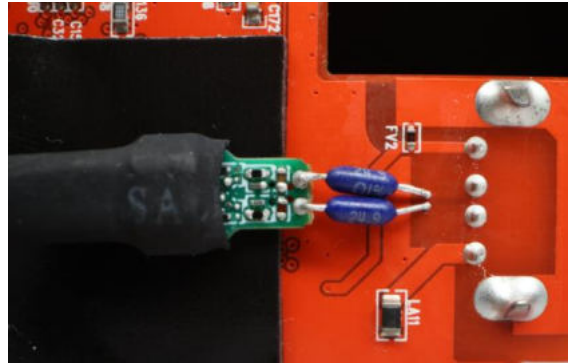

5. Clean the flux on the solder joints with board cleaner.



 To avoid overheating and damaging the circuit board, use the lowest possible temperature for the soldering iron, and do not allow the soldering iron to contact the solder points for longer than necessary.

 The PCB on the probe tip cannot directly touch the circuit board under test, as it will result in inaccurate measurements.

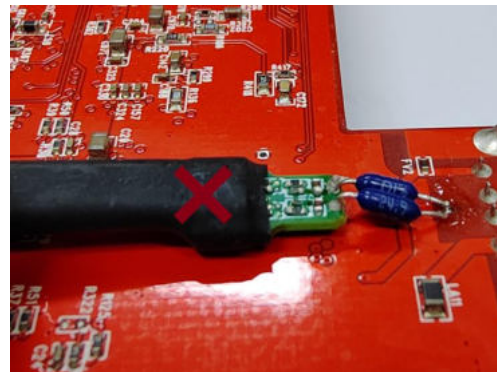
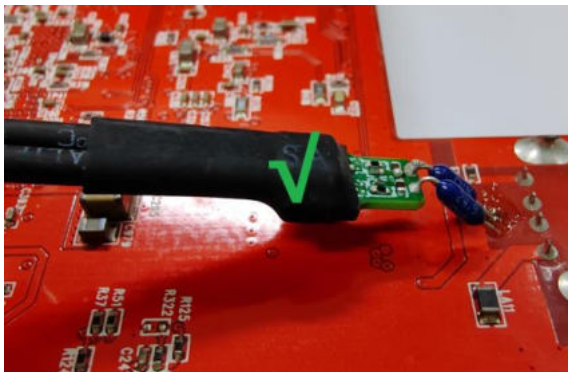

5.4.4 Removing the DSI-50 Head from the Circuit Board

1. First, remove the solder joints.

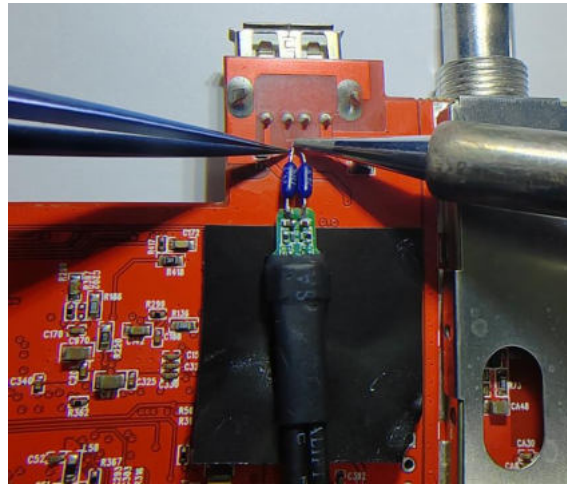

2. Then, carefully remove the probe head.



It's essential to remove the solder joints before unfastening the head to avoid damaging the probe head or the circuit board under test.



About SIGLENT

SIGLENT is an international high-tech company, concentrating on R&D, sales, production and services of electronic test & measurement instruments.

SIGLENT first began developing digital oscilloscopes independently in 2002. After more than a decade of continuous development, SIGLENT has extended its product line to include digital oscilloscopes, isolated handheld oscilloscopes, function/arbitrary waveform generators, RF/MW signal generators, spectrum analyzers, vector network analyzers, digital multimeters, DC power supplies, electronic loads and other general purpose test instrumentation. Since its first oscilloscope was launched in 2005, SIGLENT has become the fastest growing manufacturer of digital oscilloscopes. We firmly believe that today SIGLENT is the best value in electronic test & measurement.

Headquarters:

SIGLENT Technologies Co., Ltd
Add: Bldg No.4 & No.5, Antongda Industrial
Zone, 3rd Liuxian Road, Bao'an District,
Shenzhen, 518101, China
Tel: + 86 755 3688 7876
Fax: + 86 755 3359 1582
Email: sales@siglent.com
Website: int.siglent.com

North America:

SIGLENT Technologies America, Inc
6557 Cochran Rd Solon, Ohio 44139
Tel: 440-398-5800
Toll Free: 877-515-5551
Fax: 440-399-1211
Email: info@siglentna.com
Website: www.siglentna.com

Europe:

SIGLENT Technologies Germany GmbH
Add: Staetzlinger Str. 70
86165 Augsburg, Germany
Tel: +49(0)-821-666 0 111 0
Fax: +49(0)-821-666 0 111 22
Email: info-eu@siglent.com
Website: www.siglenteu.com

Follow us on
Facebook: SiglentTech



2 7 7 4 0 1 0 5 6 7